

FR
1

ES
13

PT
25

EN
37

IT
49

DE
61

INSTRUCTIONS ELECTRIC RADIATOR

.....

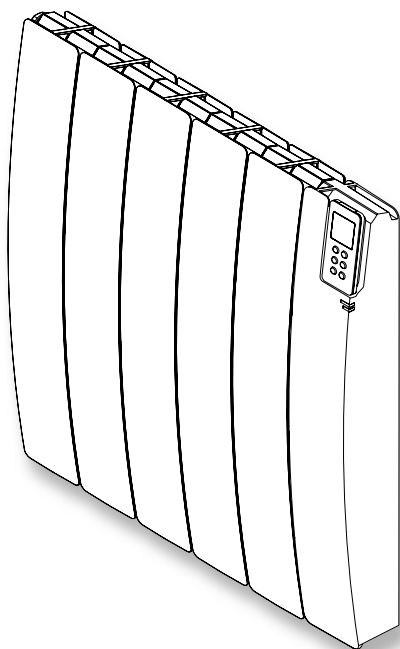

FIG. / ABB. 1

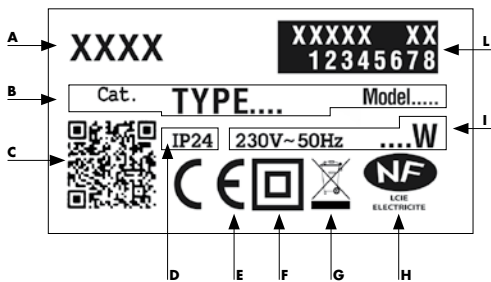

FIG. / ABB. 2

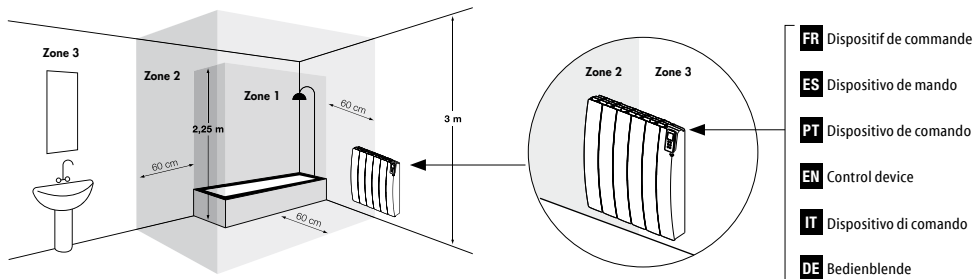

FIG. / ABB. 3

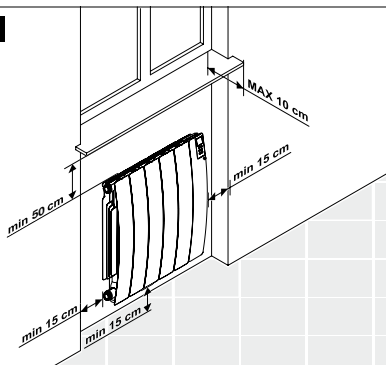

FIG. / ABB. 4

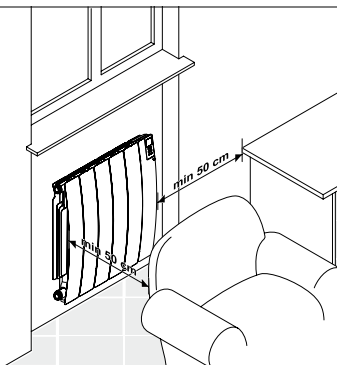

FIG. / ABB. 5

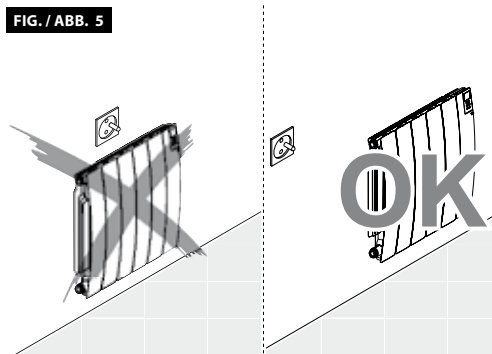

FIG. / ABB. 6

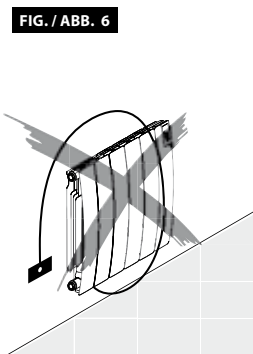
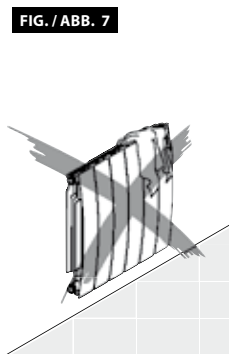

FIG. / ABB. 7



4.1 OPERATION

All functions of the appliance are controlled by an infrared remote control.

If the remote control cannot be used (flat batteries or malfunction), the radiator can be turned on and off using the "Standby" button on the side control panel (Fig. 9, Section 4.6)

4.2 OPERATION WITH REMOTE CONTROL UNIT

The appliance is controlled by an infrared remote control with LCD display.

4.2.1 LED AND BUZZER

The control LEDs allow you to immediately recognize the active mode (Fig. 9).

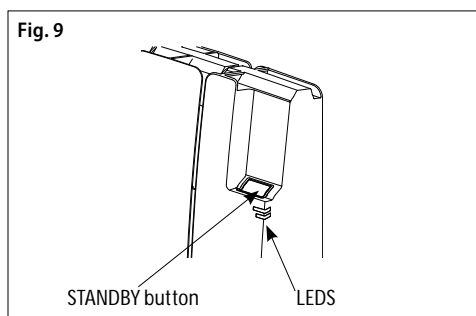

LOWER LED

Red	The heating element is on.
Off	The heating element is off.
Flashing red	Transmission of the signal from the remote control

The control box is equipped with a buzzer that signals the happening of specific events. In detail, the entry in and exit from "Standby" mode are signalled by means of specific sound signals (see Ch. 4.3).

4.2.2 INFRARED REMOTE CONTROL

The remote control communicates with the appliance by infrared rays. For efficient communication, point the remote control towards the appliance receiver lens (fig. 10).

The distance between the remote control and the receiver must not be more than 5 m.

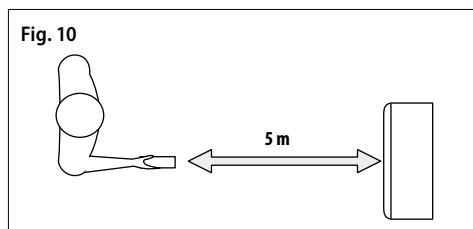

The remote control communicates with the appliance also when placed in the dedicated slot on the right side of the radiator.

When the appliance receives commands from the remote control, the lower LED flashes for about 2 seconds, followed by a beep confirming transmission of the command.

Always handle the remote control with great care and keep it in the slot on the appliance (Fig. 11). If the batteries are inserted, a magnet placed behind the slot will keep the remote control in place. It is recommended not to put within the slot objects sensitive to magnetic fields.

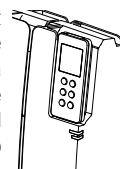

Fig. 11

As an alternative, the remote control can be placed in the wall-mount support included in the packaging.

Do not drop the remote control nor leave it exposed to direct sunlight. Do not spray water or other liquids onto the remote control. Do not rest the remote control on the top of the radiator or near other intense sources of heat.

UPPER LED

Green	Standby	
Red	Pilot Wire	
Blue	Comfort	
Yellow	Night	
White	Chrono	
Flashing green	Anti-freeze	
Flashing red	Overdrive (2h)	2h
Yellow and red alternating	Malfunctioning	
Pulse green	No power supply	

Inserting or replacing the batteries:

- Remove the cover on the back of the remote control.
- Insert two "AAA" LR03 1.5 V alkaline batteries in the correct position.
- Put the cover back.

When replacing the batteries or disposing of the remote control, the batteries must be removed and disposed of in compliance with current legislation as they are harmful to the environment.

Characteristics:

Size	100 x 42 x 20,5 mm
Power supply	"AAA" LR03 1.5 V alkaline batteries

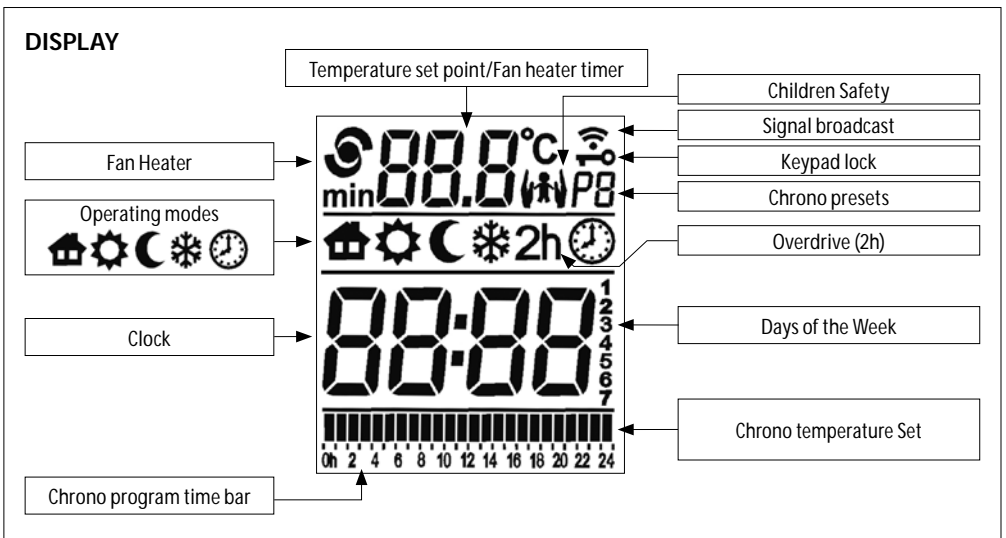
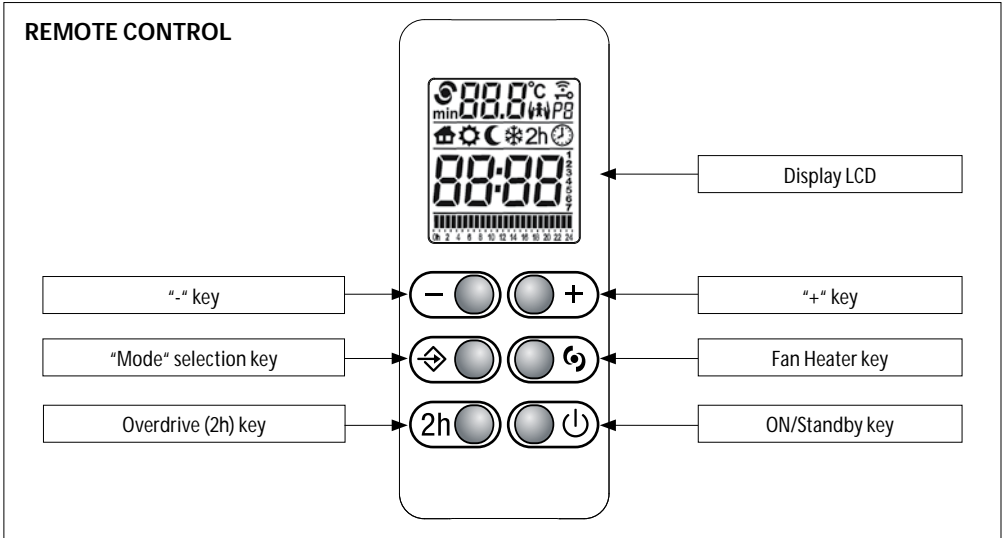

TURNING ON FOR THE FIRST TIME

After inserting the batteries, set the day of the week and time.

1
2
3
4
5
6
7

Adjust the day of the week by using the "+" and "-" keys (1=MON, 2=TUE, ... 7=SUN), then confirm by pressing the "Mode" selection key.

20:30

The hour starts flashing. In the same way, adjust the hour by using the "+" and "-" keys and confirm with "Mode" selection key.

20:30

Minutes are now flashing: repeat the same procedure.

4.3 ON/STANDBY MODE

20:30

In "Standby" mode the current time and the day of the week appear on the display. All the operating modes are suspended ("Pilot Wire" included), but the appliance is powered and waiting for command reception.

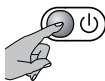

To turn the appliance on or off, press the "Standby" button.



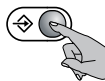

The radiator turns on in the previously selected operating mode and emits a sound. When first using the remote after replacing the batteries, the "Comfort" mode is selected. The entry into "Standby" mode is signalled by means of a double beep, the exit from "Standby" mode by means of a long beep.

4.4 OPERATING MODES



The appliance provides 5 operating modes which allow the user to heat the environment in the most suitable way with respect to his needs.

Press the "Mode" selection key to select the desired operating mode. An icon on the LCD will show the selected operating mode.

	Pilot Wire		Comfort
	Night		Anti-freeze
	Chrono		



PILOT WIRE

The temperature depends on the "Pilot Wire" command. All "Pilot Wire" commands are enabled.



COMFORT

The "Comfort" temperature corresponds to the temperature desired by the user. All "Pilot Wire" commands are disabled.



NIGHT

The "Night" mode keeps a comfortable temperature with a reduced energy consumption. All "Pilot Wire" commands are disabled.



ANTI-FREEZE

In the "Anti-freeze" mode the temperature set point is fixed at 7°C. All "Pilot Wire" commands are disabled. The appliance starts heating automatically when the room temperature drops below 7°C.





CHRONO

In this mode, you can select one of the three preset chrono-thermostat programs or the custom program. The latter lets you set a daily and weekly program with two temperature levels ("Comfort" and "Night"). All "Pilot Wire" commands are disabled.

4.4.1 PILOT WIRE

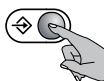
To activate the "Pilot Wire" mode:



Press the "Mode" selection key until the icon  appears on the LCD. On the appliance the upper LED turns red.

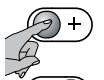



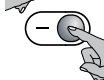



Users can only set the "Comfort" temperature on the remote control.



Select the desired temperature set point by using the "+" and "-" keys.

The home must be fitted with an automation system supporting this type of technology. In this case, correct transmission of the programming commands can be verified using the following diagram according to the mode set:

Mode	Comfort	Night (Comfort -3,5°C)	Anti-freeze	Standby	Comfort -1°C	Comfort -2°C
Signal to be transmitted						
Voltage between Pilot Wire and neutral wires	0 volt	230 volt	115 volt Negative	115 volt Positive	230 volt For an interval of 3 s	230 volt For an interval of 7 s

The temperature displayed is always the "Comfort" temperature, regardless of the currently selected "Pilot Wire" mode. If the Pilot Wire programmer is not connected, "Comfort" operating mode is selected automatically.

4.4.2 COMFORT

The "Comfort" temperature set point is the temperature desired by the user.

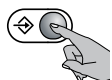

Press the "Mode" selection key until the icon  appears on the LCD. On the appliance the upper LED turns blue.



Select the desired temperature set point by using the "+" and "-" keys.



The temperature can be chosen in the interval between 7°C and 32°C.

4.4.3 NIGHT

In "Night" mode the temperature set point must not be higher than "Comfort" temperature set point. If the "Comfort" temperature is set below the "Night" temperature, the latter will be automatically adjusted accordingly.

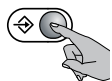

Press the "Mode" selection key until the icon  appears on the LCD. On the appliance the upper LED turns yellow.





Select the desired temperature set point by using the "+" and "-" keys.

The use of this operating mode is recommended in nighttime hours and in case no people is in the room for more than 2 hours.

4.4.4 ANTI-FREEZE

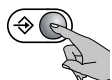
In "Anti-freeze" mode the temperature set point is fixed at 7°C. The appliance starts heating when room temperature goes under 7°C and with low energy consumption it prevents the room temperature to reach the freezing point.



Press the "Mode" selection key until the icon  appears on the LCD. On the appliance the upper LED turns green and flashing.

This operating mode is recommended when no people is in the room for more than 1 day.

4.4.5 CHRONO

In "Chrono" mode, you can select one of the three preset chrono-thermostat programs or the custom program. The latter lets you set various temperatures ("Comfort" and "Night") over a 24 hour period for each day of the week.

CHOICE OF PROGRAM

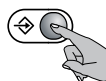

Press the "Mode" button until the icon  is displayed. The upper LED on the appliance becomes white. Then press the "Mode" and "-" buttons together and hold them both down for at least 3 seconds.

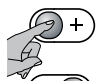
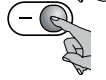

The program code (P1, P2, P3 and P4) flashes. Press the "+" and "-" buttons to set the program. Press the "Mode" button to confirm.

PROGRAM P1	HOURS	MODE
FROM MONDAY TO FRIDAY	0 - 6	Night
	6 - 9	Comfort
	9 - 16	Night
	16 - 23	Comfort
	23 - 0	Night
SATURDAY AND SUNDAY	0 - 7	Night
	7 - 23	Comfort
	23 - 0	Night

PROGRAM P2	HOURS	MODE
FROM MONDAY TO SUNDAY	0 - 7	Night
	7 - 23	Comfort
	23 - 0	Night

PROGRAM P3	HOURS	MODE
FROM MONDAY TO FRIDAY	0 - 6	Night
	6 - 9	Comfort
	9 - 13	Night
	13 - 23	Comfort
	23 - 0	Night
SATURDAY AND SUNDAY	0 - 7	Night
	7 - 23	Comfort
	23 - 0	Night

PROGRAM P4 - CUSTOM

With the "P4" program, you can set different temperatures ("Comfort" and "Night") over a 24 hour period for each day of the week.

SETTING THE CURRENT DAY AND TIME



Before setting the custom programme, make sure the time and day of the week are set correctly. If this is not the case, press the "Mode" button until the icon  is displayed.

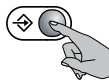

Then press the "Mode" button again and hold it down until the number indicating the day flashes.

1
2
3
4
5
6
7

Adjust the day of the week by using the "+" and "-" keys (1=MON, 2=TUE,...7=SUN), then confirm by pressing the "Mode" selection key.

20:30

The hour starts flashing. In the same way, adjust the hour by using the "+" and "-" keys and confirm with "Mode" selection key.

20:30

Minutes are now flashing: repeat the same procedure.

SETTING THE PROGRAM

Now an hourly sequence can be set for each day. Start with the first day. Choose by means of the "+" and "-" buttons, for each hour, between the "Comfort" temperature (full bar) and the "Night" temperature (empty bar).

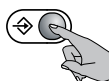
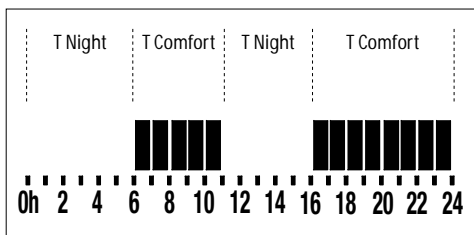

Press the "Mode" key to confirm and repeat the same procedure for each day of the week. The weekly program is now set, the appliance emits an acoustic signal for confirmation.

4.5 FUNCTIONS

The appliance has a number of special functions to customise and optimise use.

4.5.1 OVERDRIVE (2h)

The "Overdrive (2h)" can be used to heat the room quickly.



Press the "2h" button to start the "Overdrive (2h)".

The function cannot be activated when the appliance is in "Standby".

The temperature set point disappears from the display of the remote control. The upper LED on the appliance turns red and flashing. The lower LED turns red.

The appliance heats at the maximum power for 2 hours, independently from the temperature setting.

To deactivate the "Overdrive (2h)" function at any time, press the "2h" button again, the "Mode" button or the "Standby" button.

The "Overdrive (2h)" is set to stop automatically after 2 hours anyways.

IMPORTANT: If the appliance remains without power while the "Overdrive (2h)" function is enabled, the time remaining until the end of the two hour period is retained for about one and a half hours. After this time, when power is restored the date and time settings are lost. The appliance exits the function and operates in the mode selected previously.

4.5.2 CHILDREN SAFETY

When the "Children Safety" function is activated, the surface temperature of the appliance is lower than in normal operation in the active mode ("Comfort", "Night", ...) to avoid the risk of burns caused by brief accidental contact.

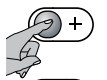

To activate the function, press the "+" and "-" buttons together and hold them both down until the icon  appears on the display.



To deactivate the function, repeat the same operation.

"Children Safety" can be activated in all operating modes, including "Overdrive (2h)". The function cannot be activated when the appliance is in "Standby".

IMPORTANT:

When this function is active, the appliance heats at reduced power and therefore the room takes longer to warm up.

Even when this function active, children should still be supervised to make sure they are not in danger.

Always avoid prolonged contact between the appliance and the body.

If the appliance is already operating or is still hot after recent use and "Children Safety" is activated, it takes at least two hours for the temperature to drop to the lower value and the function to be operational.

4.5.3 LED DISABLE

If the radiator is placed in a bedroom or in another place where the light from the LEDs may be annoying, it is possible to activate the "LED DISABLE" function. If this function is active, the LEDs turn automatically off 15 seconds after the last received command.

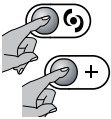

To activate the function, press the "Mode" and "+" buttons together and hold them down until "LED OFF" is displayed.

To disable the function, repeat the operation. "LED ON" is displayed.





IMPORTANT:

The "LED Disable" function is not active when the appliance is in "Standby" mode.

4.5.4 KEYPAD LOCK

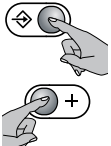
It is possible to lock the remote control keypad to avoid accidental modifications.



To activate the function, press the "Mode" and "+" buttons together and hold them both down until the icon  appears on the display.

To unlock the keypad, press the same two buttons together as before.

The "Keypad lock" icon will no longer appear on the LCD.



IMPORTANT:

The "Keypad lock" function does not inhibit the "Standby" button. This is therefore always active, even when the "Keypad lock" function is enabled.

4.5.5 FAN HEATER

The "Fan Heater" function is only available on the radiators equipped with fan heater. It is not available on this product. If the "Fan Heater" is pressed, the appliance confirms the command reception but it does not modify its current state.



ATTENTION:

If the batteries are flat, the "batt" warning appears on the display of the remote control.

4.6 OPERATION WITH THE STANDBY BUTTON ON THE SIDE CONTROL PANEL

The "Standby" button, located at the bottom of the remote control housing on the side of the appliance (see Fig. 9), can be used to turn the radiator on and off without the remote control.

To turn the appliance on and off, press the "Standby" button. The radiator comes on in "Pilot Wire" mode and emits a beep. If the Pilot Wire is connected and the programming unit is active, the appliance performs the "Pilot Wire" order set on the programming unit. Otherwise it performs the "Comfort" order. The LEDs change colour accordingly (see page 40 for a description of the colours).

The appliance emits a double beep when it enters the "Standby" mode and a single long beep when it exits the "Standby" mode.

When the radiator is turned on using the "Standby" button on the side control panel, the "Comfort" temperature is set at 19°C and all functions are reset to the default values.

To go back to controlling the appliance using the remote control, turn the radiator on using the "Standby" button on the remote control. The appliance starts operating with the modes, temperatures and functions set on the remote control.

IMPORTANT: After using the "Standby" button on the side control panel, the appliance ignores all orders transmitted by the remote control other than "Standby" and emits three beeps to indicate the error.

IMPORTANT: In case of power down due to a black-out, all the current settings are kept in memory for about 1 hour and a half. At recovery from power down after 1 hour and a half, the appliance goes to the previously selected operating mode, loosing the hour and day of the week.

If the power down happens when the radiator is in "Chrono" mode and the recovery takes place after 1 hour and a half, the appliance goes to "Comfort" mode with temperature set point 17 °C.

The user settings will be restored as soon as the first command is sent from the RCU.

5. CLEANING



Before cleaning, make sure the appliance is turned off, cold and disconnected from the household mains.



To clean, just wipe with a soft damp cloth and neutral detergent. Never use abrasive or corrosive cleaning products or solvents.



To maintain efficiency, remove the dust from the surface and inside of the appliance at least twice a year using a vacuum cleaner.

6. MAINTENANCE



Should any technical problems arise, contact a qualified professional (recognised or authorised by the dealer or manufacturer) or your local dealer.



All operations on the appliance must be carried out by a qualified professional who before performing maintenance must make sure the appliance is turned off, cold and disconnected from the household mains.



The appliance contains a precise quantity of oil. All repairs requiring the appliance to be opened must be performed by a qualified professional. In the event of oil leaks, contact your local dealer or a qualified professional.

7. TROUBLESHOOTING

The appliance does not heat up.	<ul style="list-style-type: none"> • Check if the radiator is correctly connected to the mains power grid and powered. • Check the position of the mains switch of the installation. • Increase the temperature set point on the appliance regulator. • The safety device has tripped. Eliminate the cause of overheating (for example, obstructions or covering)  • Disconnect the appliance from the household mains for a few minutes to reset the electronic system. • If it still does not heat up, contact your local dealer or a qualified professional.
The appliance heats continuously.	<ul style="list-style-type: none"> • Reduce the temperature set point on the appliance regulator. • Make sure the "Overdrive (2h)" function has not been activated accidentally. • If it continues to heat, contact your local dealer or a qualified professional.
The room stays cold.	<ul style="list-style-type: none"> • Make sure the power of the appliance is adequate for the room to be heated. • If the appliance is being used for the first time, the room takes at least a couple of hours to heat to the required temperature (setting the radiator to maximum does not raise the temperature more quickly).
Leaks of the liquid in the appliance.	<ul style="list-style-type: none"> • Turn the appliance off and contact your local dealer. • Dry the leaks using gloves to protect from the chemical products. Keep children and pets away from the liquid.
The appliance does not respond correctly to orders received from the Pilot Wire control unit.	<ul style="list-style-type: none"> • Disconnect the appliance from the mains power supply (switch off the mains switch by moving it in the "0" position). Make sure the connection is correct (Fig.8) and the control unit is functioning correctly. • Contact a qualified professional.
The upper LED becomes alternating yellow and red.	<ul style="list-style-type: none"> • The temperature sensor is malfunctioning. Turn off the appliance and contact your dealer.

8. GUARANTEE



You are recommended to keep all parts of the packaging in case the appliance needs to be returned to the dealer. The appliance must arrive complete and undamaged in order to maintain the validity of the guarantee.

The manufacturer guarantees customers all the rights specified in European Directive 1999/44/EC and the consumer rights recognised by national legislation.

The guarantee specifically covers all non-conformities and production defects present at the moment of sale or becoming evident within two years from the date of purchase and gives the customer the right to free repair of the defective product or replacement should repair be impossible.

The above rights are invalidated in the following cases:

- defects caused by uses other than those specified in the instructions, which are an integral part of the sales contract;
- defects caused by accidental breakage, negligence or tampering.

Operations involved in installation, connection to the household mains and maintenance described in these instructions are not covered by the guarantee.

The Manufacturer declines all liability for damage or injury caused directly or indirectly to people, objects or pets as a result of the failure to apply these instructions, with particular reference to warnings regarding installation, start-up and use of the product.

To claim the above rights, the Customer must contact his/her dealer and present a valid proof of purchase issued by the seller, complete with date of purchase.

9. DISPOSAL



Make sure the power cable is disconnected from the power line before performing any operation. To remove the appliance, follow the procedure for fixing to the wall in reverse (Scheme 1).

To dispose of the appliance, comply with current legislation for the disposal of oil and management of waste.



Important information for correct disposal of the product in accordance with EC Directive 2012/19/EC.

At the end of its working life, the product must not be disposed of as urban waste.

It must be taken to a special local authority differentiated waste collection centre or to a dealer providing this service.