

# TELICA WIFI PLUS

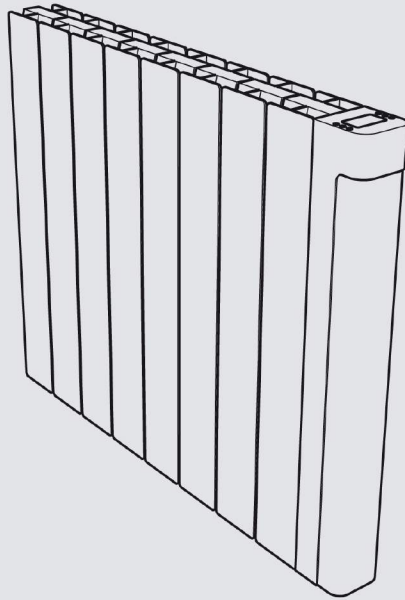

DELTACOLOR



**CNM Online**

T: 01977 663331

E: [cnmservice@cnmonline.co.uk](mailto:cnmservice@cnmonline.co.uk)

Unit 2, North Point Business Park, Selby Road, Eggborough, North Yorkshire,  
DN14 0JT



## **WARNING FOR WIFI THERMOSTAT**



The device allows remote control through a WI-FI connection

It is mandatory to respect a minimum distance of at least 20 cm from the habitable area for humans.





## CHILDREN SAFETY

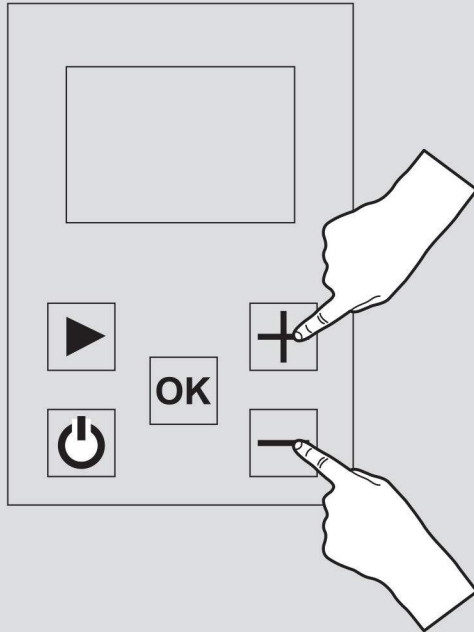

### Locking the keypad « 🔒 »

To lock or unlock the keypad, simultaneously push keys **-** and **+** for 5s.



This function is used to lock the keypad, excepting for the On/Off key .

In this mode it is not possible to change the program configuration, the temperature or activate the other functions.

## INSTALLING THE DEVICE

**Before connecting the heater, turn off the electricity at the general circuit breaker.**

- The heater is a class II appliance, so it can be installed in all rooms of the house including in volumes protection 2 and 3 of a bathroom (IP24).
- The heater must be installed 15 cm minimum of any obstacle (shelves, curtains, furniture etc.).

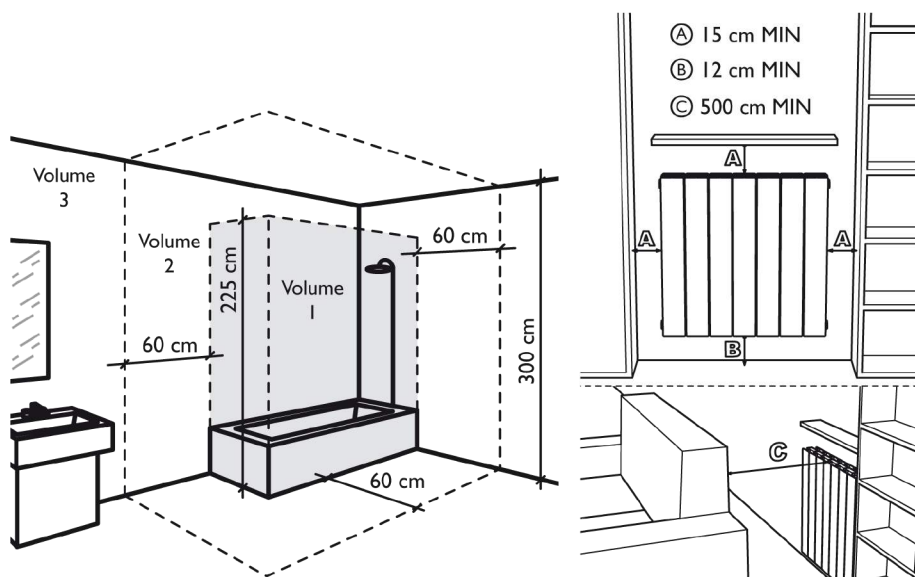

## POWER SUPPLY AND ELECTRICAL CONNECTIONS

- The power supply to the heater must be protected, according to the standards in force, by a 30 mA differential switch and a protection device against overcurrents adapted to the characteristics of the connecting line.
- Before the first use, check that the voltage used corresponds to the one indicated on the device.
- This heater is a Class II appliance (double electrical insulation).
- The connection to earth is prohibited.
- **The three wires must be connected** in one electrical connection box complies with the standards in force.
- **You must isolate the pilot wire if it is not used.**
  
- Single phase power supply 230 V ~ ± 10% 50 Hz.
  
- Blue / gray thread: Neutral
- Brown Wire: Phase
- Black wire: Pilot wire

## POWER SUPPLY AND ELECTRICAL CONNECTIONS

Use the product as shown in Figure 1. Do not ever put towels or clothing on the outer frame (figure 2). Incorrect use may cause dangerous overheating and compromise the operation of the device.

To clean the unit, do not use any chemicals, but use a damp, non-abrasive cloth.

1

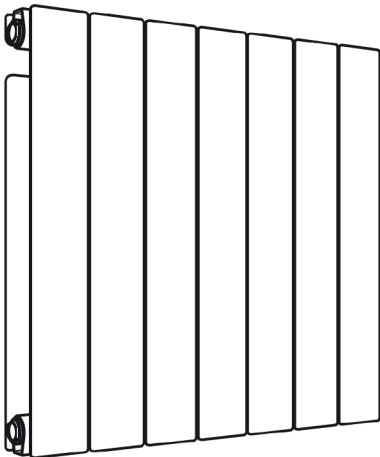

2

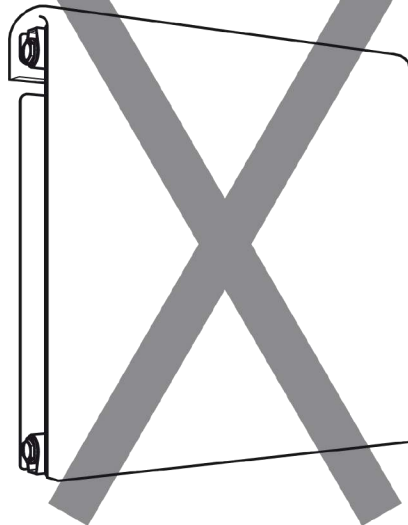

## FIXINGS THE WALL BRACKETS

1. Before mounting the radiator to the wall, check that the distances shown in the drawings “INSTALLING THE DEVICE” are respected (see p.5).
2. Determine by looking at the table here below your radiator model and respect the heights and width indicated to mount the wall brackets For help with installation, refer to drawings 1 and 2 (see next page).

<b>Power</b>	<b>H</b>	<b>L</b>	<b>Wall brackets</b>
500 W	500 mm	210 mm	3
750 W - 900 W	500 mm	260 mm	3
1250 W - 1500 W	500 mm	500 mm	3
1800 W	500 mm	660 mm	3
H = Height fixing holes L = Width fixing holes			

3. Secure the brackets to the wall using cleats (not supplied) adapted to the wall structure on which the radiator is positioned.
4. Once fixed, close the security system with the screws as indicated on drawing 3 (see next page).

### NOTE

**Screws and tiles are not supplied**

1

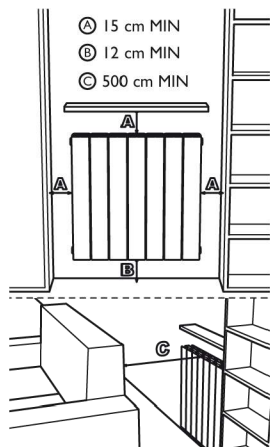
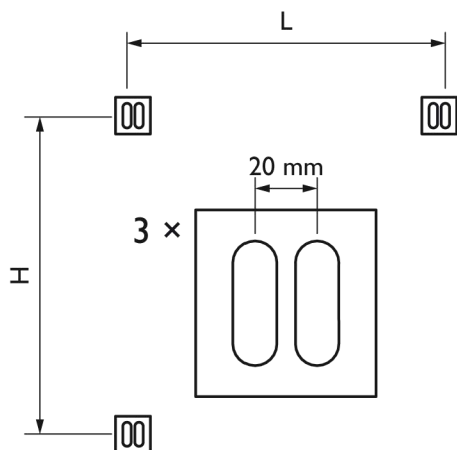

2

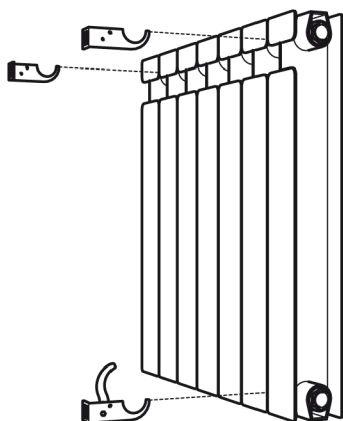
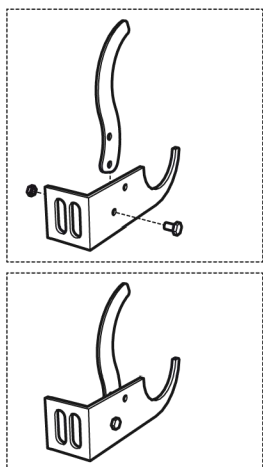

3

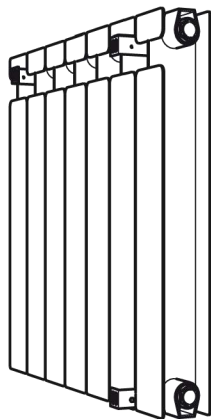
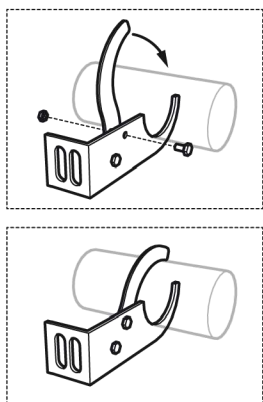



# USER INTERFACE FEATURES

## Display

The display is backlit.



1 - Information on the operating mode/thermostat menu, time and WiFi connection.

2 - Information on:

- Thermostat operating mode: temperature setting, behaviour indicator, measured temperature, radiator heating indicator.

- Parameter setting: Display of the actual value of the settings made.

- Programme selection for mode AUTO.

The keypad has 5 keys:

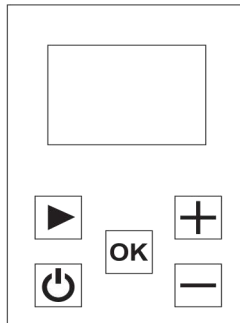

	ON / OFF button (Heating on / off)
	minus key
	Validation button
	Plus key
	Navigation key

# FIRST SWITCHING ON AND INSTALLATION

When the thermostat is switched on or after the unit has been reset/reset, this first screen is displayed.

The number corresponds to the software version of the unit.

The second screen depends on the status of the thermostat:

•The first time the unit is started, the user will be able to directly configure the WIFI connection, the date and time of day.

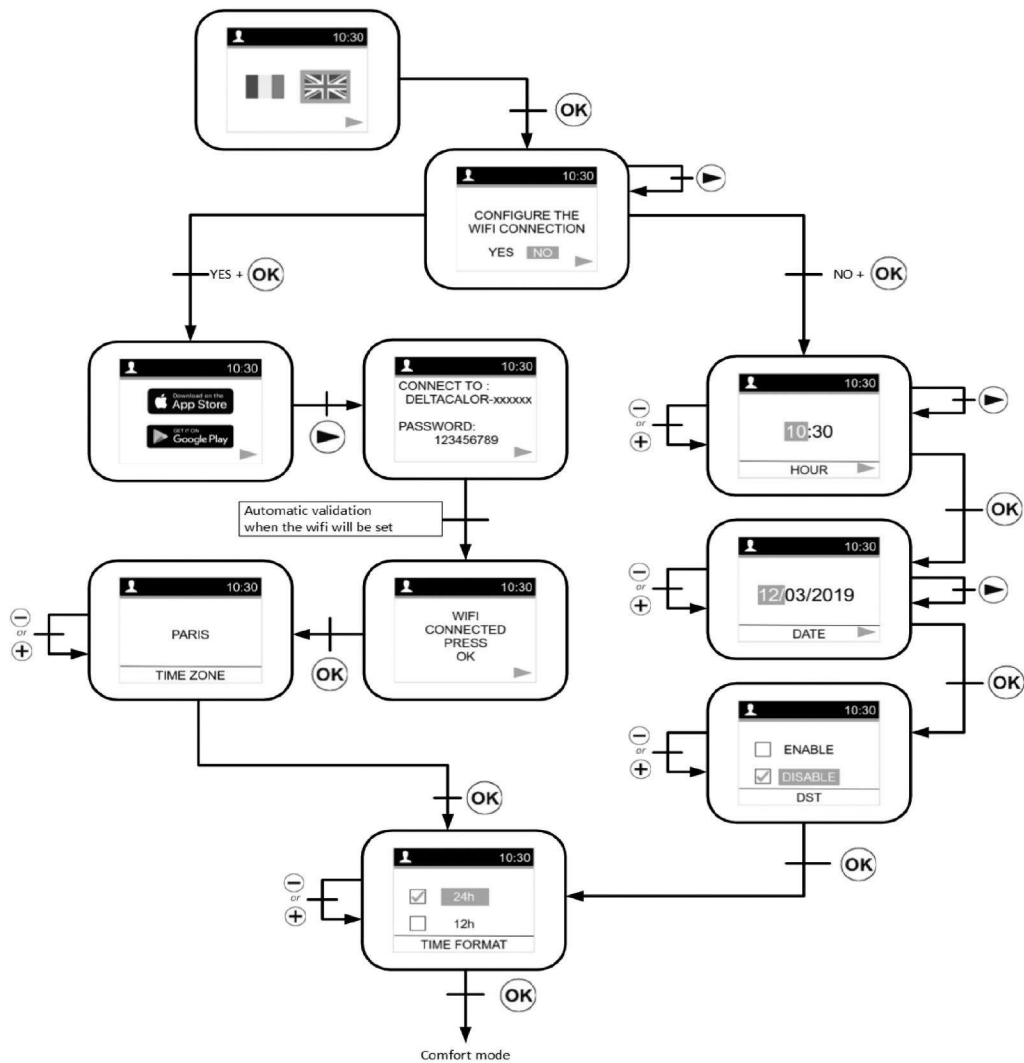

To configure a radiator and associate it to your WIFI network with the “DELTACALOR CONFORT” application go to page 60.

After a power cut, this will be the screen page of the current mode.

After a unit reset or a very long power cut, the screen page of the modification time will be displayed.

# MODE SELECTION MENU

To change the current mode of the thermostat, the user must press the right navigation key to access the menu selection.

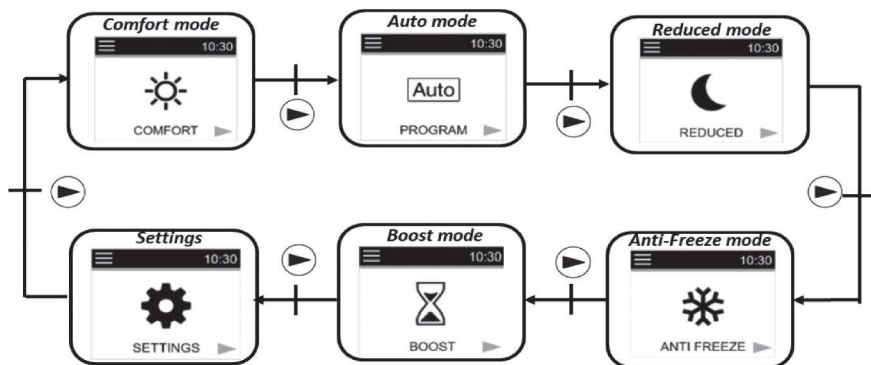

The user moves the frame cursor to select a working mode.

To select a mode, press **OK**.

Confirm the selected mode by pressing the key **OK** otherwise the thermostat will automatically return to the last selected mode ☒, ☒, ☒, ○ **Auto**.

By touching **⏻**, users can access the heating on/off mode immediately:

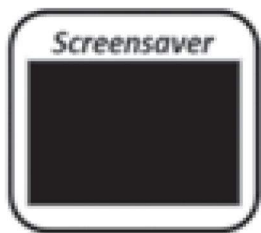

If there is no activity on the keypad for 5 to 10 seconds, a screen saver is displayed

This screen saver could be the value of the measured or zero temperature:



# Definition of operating modes

## Comfort mode

In this mode, temperature of the comfort setting will be followed all the time. On the screen saver (backlighting on), if you press the key  $\ominus$  or  $\oplus$ , keys, the set temperature for comfort starts flashing and you can change it. If you press the  $\text{OK}$  key or wait 15 seconds without taking any action, the value of the setting is confirmed. This setting will be used in **Auto** mode during the high phase of the selected programme.  From the screen saver (backlight on) if you press  $\text{OK}$  you can switch the display from the measured temperature to the set temperature. If you press the  $\blacktriangleright$ , key, the navigation menu will be displayed. If you press the  $\text{⏻}$ , key, the thermostat is deactivated. Preset value: 19°C.

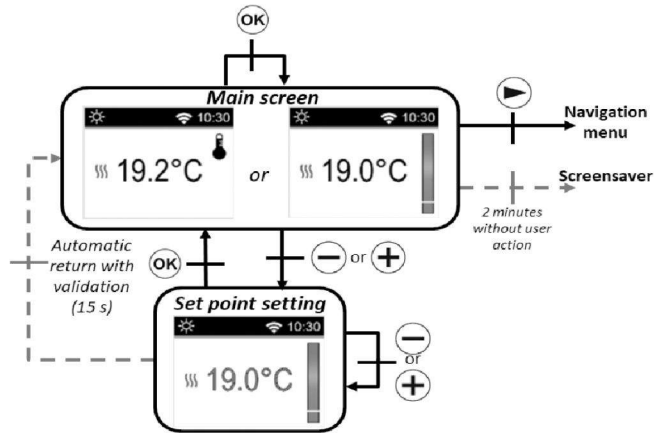

Interval: 10°C to 30°C. (the maximum value can be changed in the settings menu).

## Eco mode

In this mode, the unit operates at a reduced configured temperature. On the screen saver (backlighting activated), if you press on key  $\ominus$  or  $\oplus$ , the reduced configuration temperature starts flashing and you can change it. If you press the  $\text{OK}$  key or wait 15 seconds without taking any action, the value of the setting is activated. This setting will be used in mode **Auto** during the high phase of the selected programme . On the screen saver (backlight on), the  $\text{OK}$  key allows you to switch the display to from the measured temperature to the set temperature. If you press the  $\blacktriangleright$ , key, the navigation menu will be displayed. If you press the  $\text{⏻}$ , key, the thermostat is deactivated. Preset value: 17°C.

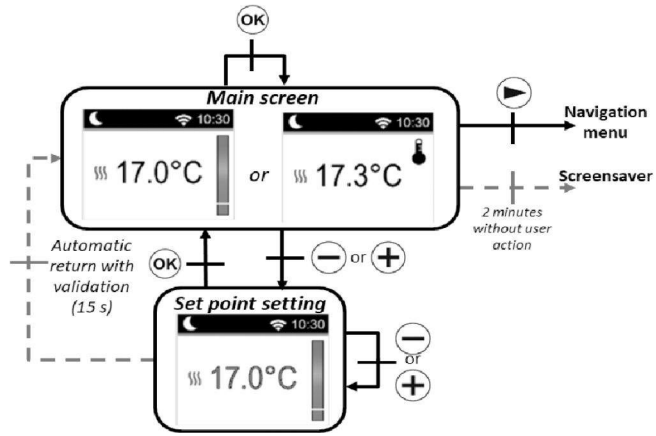



Range: 5.0°C to 19°C (or 0.5°C lower set temperature if lower).

## Automatic mode

In this mode, the thermostat will follow the chosen programme (from P1 to P9 integrated or from U1 to U2 customised) according to the real time and the Comfort and reduced  set temperature.

On the main screen, the key  enables you to switch from the display of the measured temperature to the set temperature.

If the user presses the keys  and , they can ignore the temperature of the current programme for up to 2 hours by changing the value. The value starts flashing and can be changed.

If you press the  key or wait 15 seconds without taking any action, the value of the setting is confirmed. The symbol of a hand is displayed when the

override function is activated. This override continues until the next



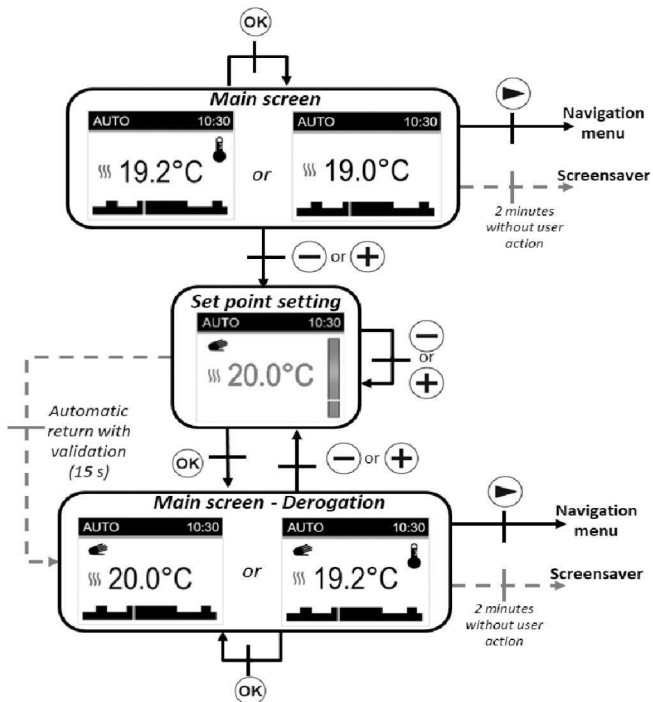

phase (the programme switches to another temperature setpoint) or for a maximum of 2 hours.

If you press the  key, the navigation menu will be displayed.

If you press the  key, the thermostat will switch off.



## Frost protection mode

In this mode, frost protection, the temperature setting will be monitored all the time. On the main screen, if you press the  and , keys, the frost protection temperature setting will start to flash and can be changed. If you press the  key or wait 15 seconds without taking any action, the setting point of the value is confirmed. On the screen saver (backlighting activated),  you can change the measured temperature display to the set temperature.

If you press the  key, the navigation menu is displayed.

If you press the  key, the thermostat is turned off.



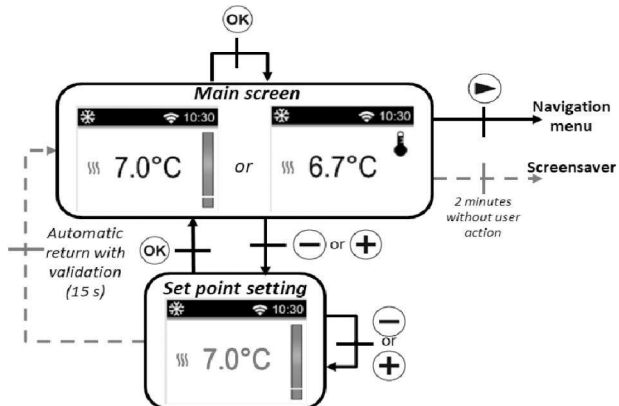

Preset value: 7°C

Interval: from 0.5°C to 10°C.



**Heating Off mode** 

In Heating Off mode, the symbol is displayed in OFF mode .

After pressing one of the 4 key (   ) , the measured temperature is displayed.

After a few seconds, this information is no longer displayed.

This mode applies a zero reference temperature.

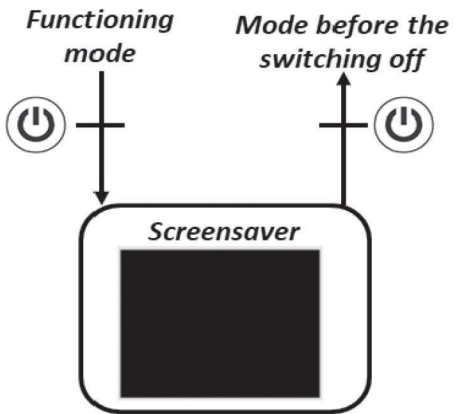

If you press the , key, the thermostat reactivates in the last selected mode.



**Boost mode** 

This mode allows users to increase the heating with the set maximum temperature for a preset time interval.

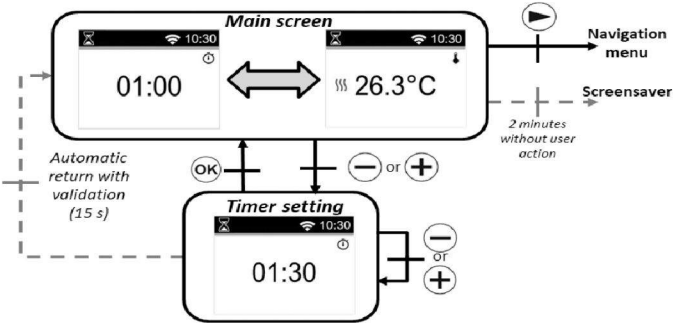

Time configuration:

The time value is set using the  and  keys. The key is used to confirm the time value and the period for which the temperature increases rapidly



Preset value: 1 hour

Interval of values: 30 minutes, from 1 hour to 24 hours, 1 hour intervals.

When the boost is activated, the remaining time and the measured temperature are displayed. If you press  or  you can change the settings.

If you press  for one second you will access the menu for selecting the mode.

If you press  you stop the unit and reset the timer.

# Definition of the “CONFIGURATION” menu

When the user accesses the “CONFIGURATION” menu, they can choose between different groups of settings or actions:

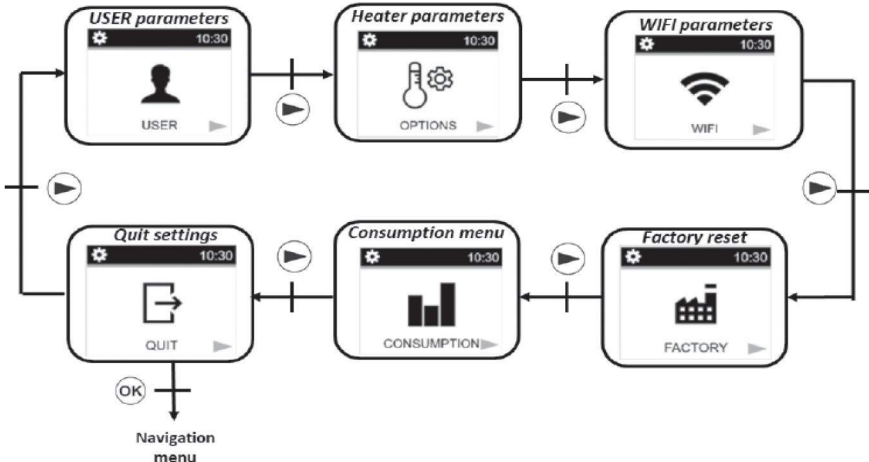

To select a menu, the user must press the **OK** key. Navigation is performed via the **▶** key. To exit the settings menu, the user must choose the “EXIT” setting and press the **OK** key. Another way to exit the settings menu is to press **▶** without releasing the key for a few seconds.

## User settings

The setting configuration menu is selected by pressing the **▶** key. The configuration is done by pressing the **OK** key. To exit the settings menu, select the “EXIT” setting and press the **OK** key. Another way to exit the settings menu is to press and hold the key **▶** for a few seconds.

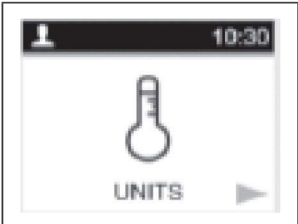

### Degrees measurements units «UNITS»

Preset value: °C (Celsius)  
Other choice: °F (Fahrenheit)

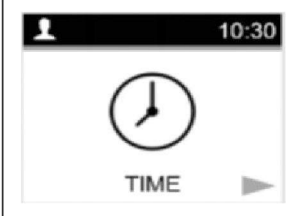

Menu «DATE AND TIME» to configure the time and date.

There are two ways to configure the time and date of the thermostat depending on the WIFI status (activated or not):

**FIRST METHOD: WIFI OFF**

**Changing the time:**

Select the hours and minutes with **▶**. Change the number of the values with keys **-** and **+**. Confirm your settings with the **OK** key.

**Time format:**

Select the 24H or AM / PM format with the **-** and **+** keys. Confirm your configurations with **OK** key.

**Automatic time change:**

Select whether the time change (summer/winter time) will take place automatically or not using **-** and **+** keys. Confirm your settings with the key **OK**.

**Changing the date:**

Select the day or month or year with **▶**. Change the values with keys **-** and **+** keys. Confirm your settings with the key **OK**.

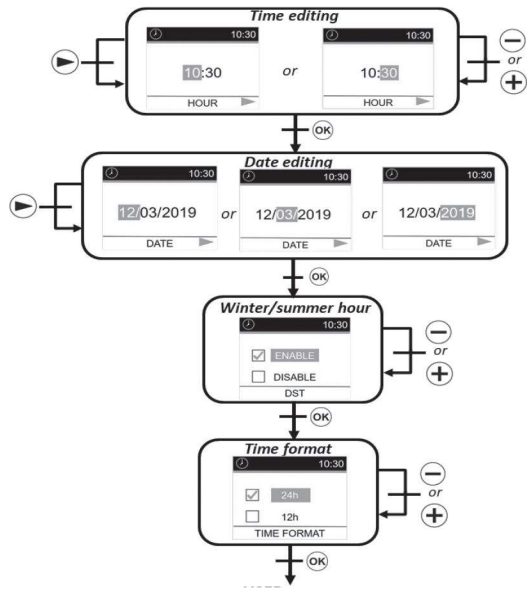

**SECOND METHOD: WIFI ON**

**Time zone:**

Select the world time zone with the **-** and **+** keys. Confirm your settings with the key **OK**.

**Time format:**

Select the 24H or AM/PM format with the **-** and **+** keys. Confirm your settings with the key **OK**.

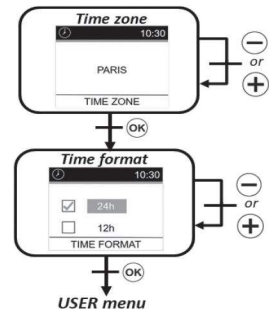



## VIDEO SCREEN OFF

When no mode is active, the screen appears as below:

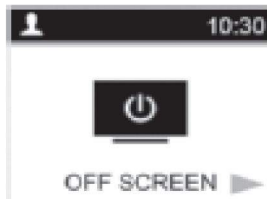

Default value: none

Other choice: Measured temperature (7h00 to 23h00)

## Program

this menu allows you to select the programming to be applied in auto mode AUTO.

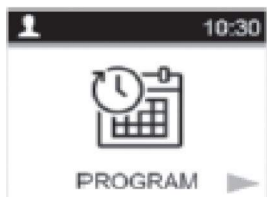

### Program:

Select "Selection" with the . Confirm your settings with the key .

### Selection:

Select the programme number with the key . Select the day with the keys and . Confirm your settings with the key .

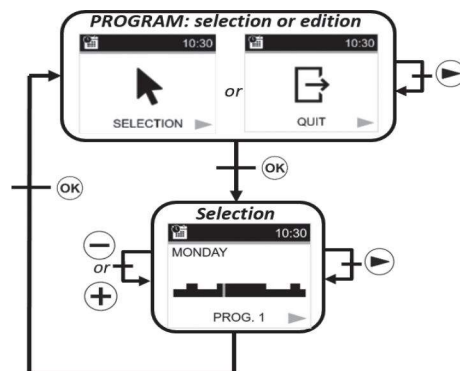

## Language selection

Default value: English

Other choice: French, Italian, German and Spanish

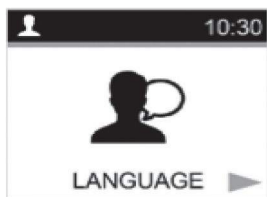



### Exit the settings menu

If you press the key **OK** you can exit the USER settings menu and return to the SETTINGS menu.

### Heater options and settings

To select the setting configuration menu, press the **L**key. The configuration is done by pressing the **OK** key.

To exit the settings menu, the user must choose the setting “EXIT” and press the **OK** key. Another way to exit the settings menu is to press and hold the **L**key for a few seconds.

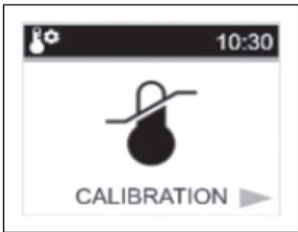

### Calibrating the temperature sensor:

Calibration must be done after 1 day of use with the same configuration temperature, as described below:

1. Place a thermometer in the room, at the same distance from the floor as the thermostat. Check the actual room temperature after 1 hour.
2. Enter this value in the calibration settings menu using the keys **-** and **+** to enter the actual value.
3. Press **OK** to confirm the calibration.

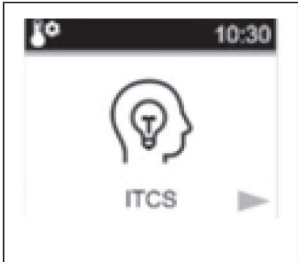

### ITCS - Intelligent Temperature Control System (adaptive start heating in AUTO mode)

This function is described in “Special functions”. This setting activates or disables this function.

Preset value: Yes (function activation)  
Other options: No

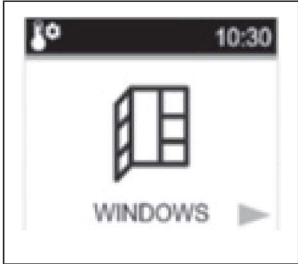

### Automatic detection of an open window

This function is described in “Special functions”. This setting allows you to enable or disable this function.

Preset value: Yes (function activation)  
Other options: No

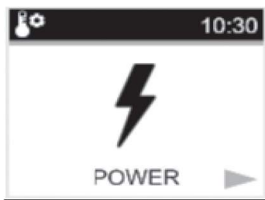

### Heating power

This setting corresponds to the power of the heater. This setting must be configured to calculate the energy consumption and to select the setting parameters.

Preset value: 900

Other options: 1000, 1500, 1800, 2000

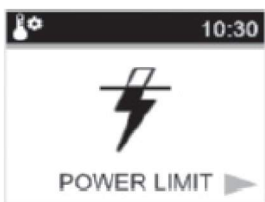

### Power limit

This setting allows the radiator power to be reduced manually.

Preset value: NO (100%)

Other options: NO (100%)/75%/50%



### Boost temperature programming

Temperature setting when the boost control is active.

Preset value: 30°C

Other options: 20°C to 30°C

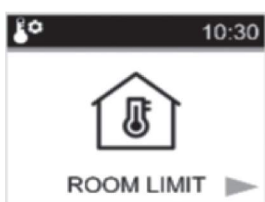

### Room temperature limitation

Limitation of the maximum room temperature that can be set remotely.

Preset value: 30°C

Other options: 20°C to 30°C

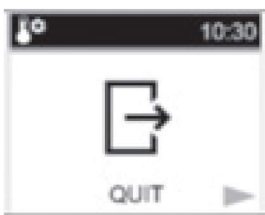

### Exit the Settings menu

If you press the **OK** key you can exit the settings menu and return to normal operation

## WIFI settingd

To select the setting configuration menu, press the **▶** key. The configuration is done by pressing the **OK** key.

To exit the settings menu, the user must choose the setting “EXIT” and press the **OK** key. Another way to exit the settings menu is to press and hold the **▶** key for a few seconds.



### WIFI INFORMATION:

- This menu shows the WIFI information:
- Connection status: CONNECT, AD HOC mode, NOT CONNECTED and CONNECTION;
- SSID;
- IP address;
- MAC address.



### CONNECTION

Activates the unit's cloud connection.

Note: The unit must be configured beforehand in ad hoc connection activation mode (see below).

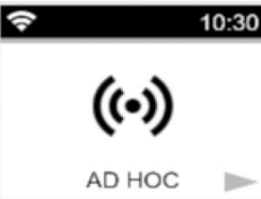

### AD HOC (direct mode):

Activates the AD HOC mode. This mode allows the WIFI network unit to be configured using the application.

When the thermostat is operating in this mode, the user can see a different antenna on the display:

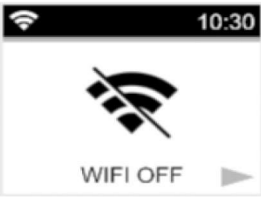

### WIFI OFF

Deactivation of the WIFI connection.



### RESTORE WIFI SETTINGS

delete all configured WIFI connections.

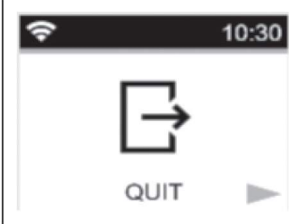

## EXIT THE MENU

Press the button **OK** to exit the WIFI menu.

## Reset to factory settings

All thermostat settings will be loaded with the factory settings.

If you press the **OK**, key, the thermostat resets the settings to the factory default settings.

The thermostat is reset to the predefined factory settings:

- Nominal temperatures;
- SETTINGS;
- Reset the time;
- Energy consumption;
- WIFI settings.

## Consumption recording menu

This mode is only available if the radiator power has been configured by the user.

Press **▶** to change the time interval for the power consumption display (last 24 hours, last 7 days and lasts 30 days).

If you do not press any key, the thermostat will return automatically to the previously selected mode.

Press **OK** to return to the Menu CONFIGURATIONS.

If you press **-** or **+** for a few seconds, the power consumption values are restored.

Another way to exit the settings menu is to press and hold the **▶** key for a few seconds.

If you press **⏻** you stop the unit.

The estimated values are saved in the memory every 4 hours and every time the user displays this menu.

If **POWER OFF** is active, the values are maintained for the next 12 hours.

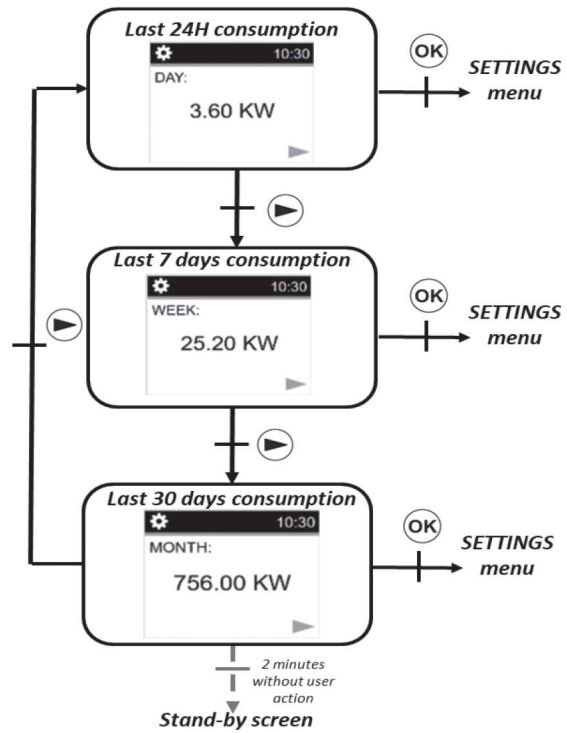

### **Description of the integrated program**

- P1: morning (7h-9h), evening (17h-23h), and weekend (8h-23h)
- P2: morning (7h-9h), noon (12h-14h), evening (18h-23h) and weekend (8h-23h)
- P3: day (6h-23h), Saturday (7h-24h) and Sunday (night (0h-1h), day (7h-23h))
- P4: evening (15h-23h) and Saturday (7h-24h) and Sunday (night (0h-1h), day (7h-23h))
- P5: morning (6h-8h), evening (21h-23h) and Saturday (morning 7h-9h), evening 18h-24h) and Sunday (morning (7h-9h), evening (18h-23h))
- P6: morning (6h-8h), noon (14h-21h) and weekend (7h-21h)
- P7: office from Monday to Friday (7h-19h) and weekend (off)
- P8: Warehouse: from Monday to Friday (8h - 19h) and Saturday (8h -18h) and Sunday (off)
- P9: Second house: from Friday (1pm) to Monday (7am)

### **Backup of settings**

This thermostat automatically saves its data (set point values, user programme and settings) when:

1. The user confirms the changes made to the settings by pressing the confirmation button.
2. The unit's backlighting is switched off.

It also saves the estimated values of its energy consumption:

1. Every 4 hours
2. When the user enters the consumption mode

### **Special functions**

#### **ITCS: Intelligent temperature control system**

This function can be activated using the "ITCS setting" in the settings menu (see chapter menu setting "Settings menu").

This function allows you to activate your system in advance (2 hours maximum) when your thermostat is in Auto mode. This function ensures the required temperature at the scheduled time according to your weekly programme.

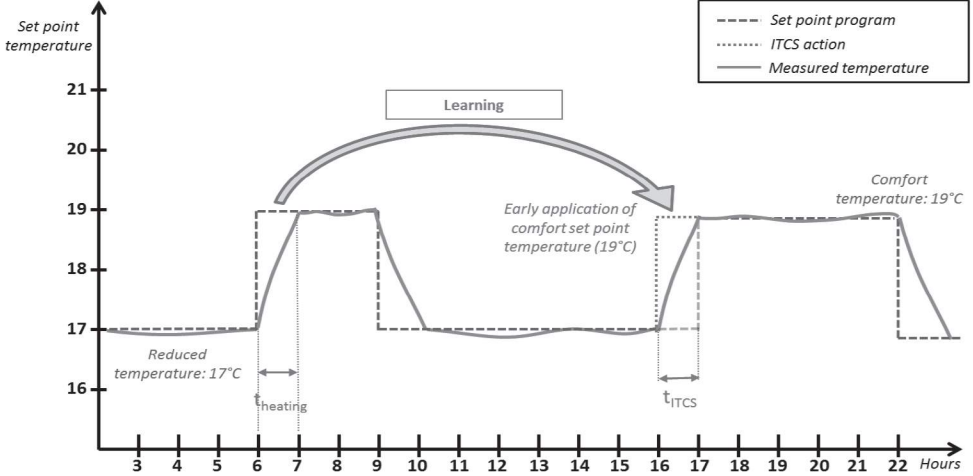

To operate, the ITCS system automatically performs several time and temperature measurements. The objective is to estimate a heating rate for the system. With this value, the system can calculate the heating activation time in advance.

When the thermostat is switched on for the first time, a default time for reaching the set temperature is applied. This value will be adjusted by new measurements each time the programme is changed to compensate for changes in the outdoor temperature. Afterwards, the thermostat can be programmed without adjustment because it will do so automatically.

When the system performs an adaptive start, a hand logo is displayed on the screen.

**Open window detection**

This function can be activated with the “window setting” in the menu setting.

This function is performed by measuring and recording the temperature development over the last 20 minutes:

- First step - Window open activated: the thermostat switches to the “Window open” (status (and the temperature value flashes) when the temperature has dropped
- by more than 1.5°C in the last 20 minutes, when the unit was switched on and is heating.
- Second step: for 20 minutes, if the temperature exceeds 0.3°C, the window opening status is cancelled and the remote control automatically returns to the current mode setting

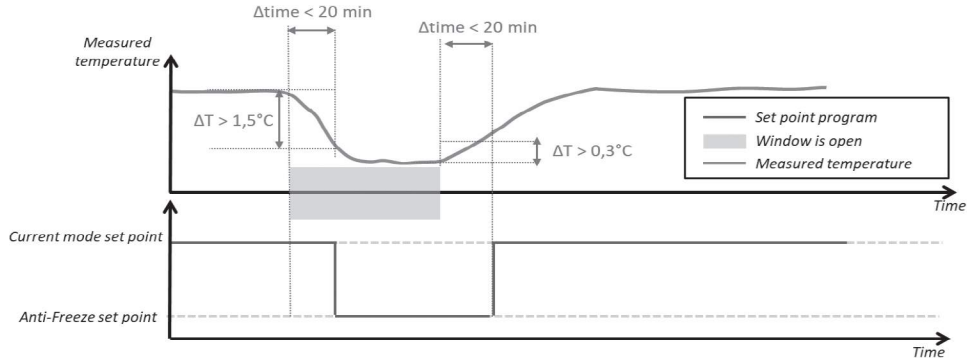

### Saving data in the event of prolonged power failure

This unit can maintain the time countdown for up to 12 hours after a power failure.

If the power failure lasts too long, the time and date will be reset to the factory settings. You will need to reset these value

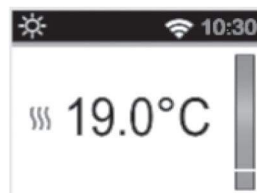

### Keyboard lock

To activate this function, you must press the  $\ominus$  or  $\oplus$  keys simultaneously for 5 seconds. All the keys are locked except the heating On / Off  $\text{⏻}$  key.

This function is accessible in any mode. The  $\text{🔒}$  icon is displayed on the screen:

To unlock the keypad, you must repeat the same procedure. NOTE: In the event of a power cut, the configuration is maintained.

### **Pilot wire control mode**

Pilot wire command	Screen	Pilot wire command	Screen
Comfort		ECO	
Comfort-1°		Frost protection mode	
Comfort -2°		Stand-by	





## Priority in pilot wire sequences

Mode set on the thermostat	Pilot wire control mode	Actual mode set
MODE AUTO (comfort)	Comfort	Comfort
	Comfort -1°C	Comfort -1°C
	Comfort -2°C	Comfort -2°C
	Comfort -3.5°C / eco	Lower value between Comfort -3.5°C and 19°C
	Antifreeze	Antifreeze
	Stop	Stop
MODEAUTO (eco)	Comfort	Temperature set in ECO mode
	Comfort -1°C	
	Comfort -2°C	
	Comfort -3.5°C / eco	Lower value between the temperature set in ECO mode and "Comfort -3.5 °C"
	Antifreeze	Antifreeze
	Stop	Stop
MODE AUTO (manual)	Comfort	Manually set temperature
	Comfort -1°C	
	Comfort -2°C	
	Comfort -3.5°C / eco	
	Antifreeze	
	Stop	

If the open window detection  is activated and this function detects the opening, the thermostat follows the rules described in the paragraph "Open window detection". The thermostat displays the value of the set temperature applied to the heater. It takes into consideration the order of priority shown above.

### Description of errors

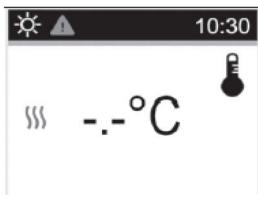
If the sensor is turned off or disconnected, an error message will appear on the thermostat display.

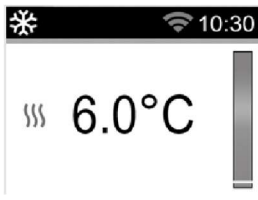
Sensor problem		the message «-» is accompanied by the icon  flashing and the logo  on the display.
WIFI connection problem		The WIFI logo is red

# SMARTPHONE APPLICATION

2. Click “more” to add a new device

## General information

The application is only available for the IOS and Android platforms.



The application allows you to configure the WIFI component and remotely control the radiator. First of all download the free application

“DELTACALOR COMFORT”



on your mobile (smartphone).

With the application the user can add a device to the application and configure the WIFI network.

1. Click on “list of my installations” to show the existing installation or add a new installation.

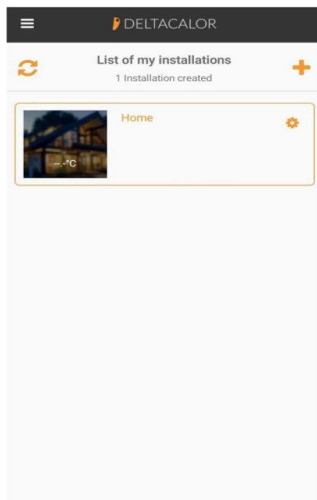
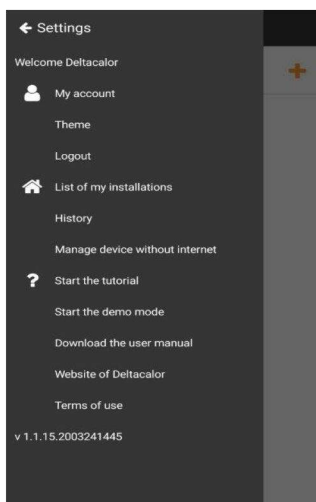

3. Wait for the WIFI to connect.

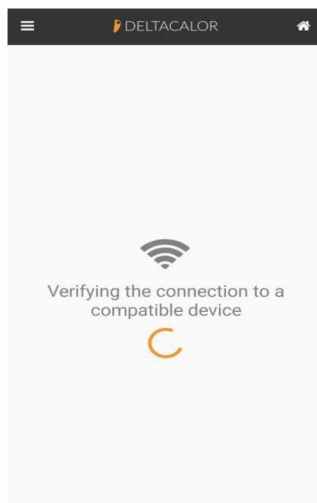

4. If the smartphone is not connected to the unit, access the phone's WIFI settings by clicking WIFI setting. Then return to the application.

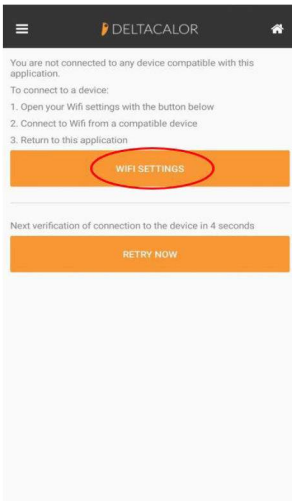

5. Create the installation, the new room and add the name of the device.

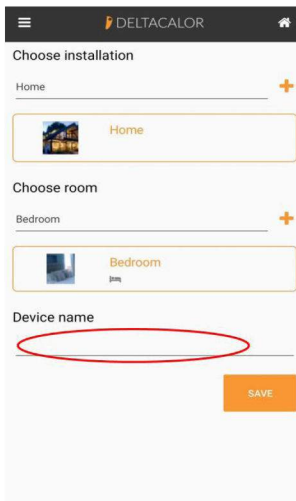

6. Save the configuration

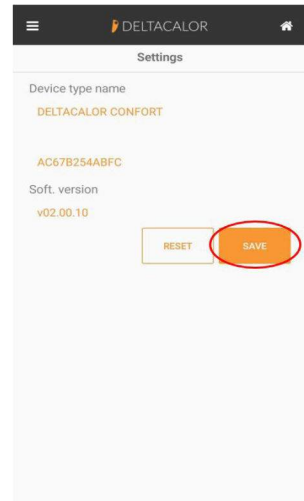

7. Connect the unit to the Internet, select the network and enter the password.

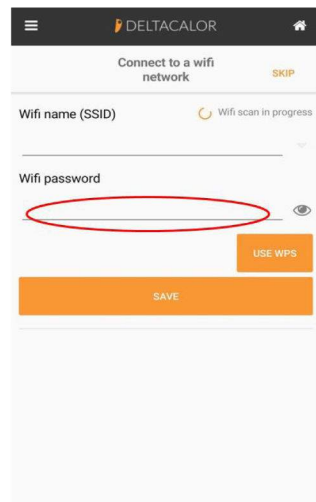

8. Press the key until the device network configuration is complete.

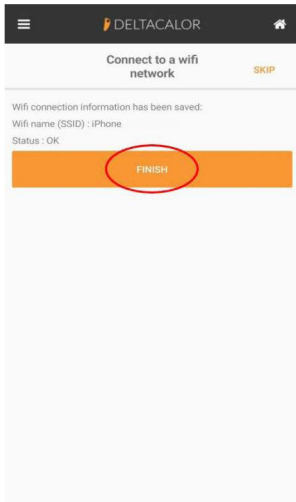

- You can be in Eco mode, Frost protection mode, or Auto mode with a reduction imposed by the power manager. Switch to Permanent Comfort mode or increase the setting.
- Check that your appliance is not near an air intake.
- Check that the set temperature has not been changed

## TROUBLESHOOTING

### **The device does not heat enough**

- The device could be set in ECO MODE or ANTI FREEZE. You should set the COMFORT mode or increase the setting temperature

### **The device heats continuously**

- Check the position where the heater is installed: it should be far from any air flow.
- Check to be set the proper temperature.

**If the problem persists you should interrupt the power supply to the heater and wait for one minute at least before turning it back on. If the problem persists again, please contact the technical assistance.**

## VIDEO TUTORIAL



Follow the instruction manual for pairing the Wi-Fi thermostat or watch the video tutorial linked to the QR code here at the side.

# TECHNICAL FEATURES

Product	Electric radiator	
Application	Domestic use	
Insulation class	CLASS II	
IP Class	IP24	
Plastic color	White	
Power cable color	White	
Temperature selection	Numeric	
Adjustment mode	Numeric with 5 buttons	
Operating mode	Comfort, Night, Antifreeze, ECO, Chrono, Vacation, Open window detection, Child protection, Adaptive start control, Key lock	
Temperature range	0.5 + 30°C	
Maximum power	1800W	
Frequency band	2400MHz to 2484MHz	
Supply voltage	230Vac 50Hz	
Electric connections	3 cables: neutral (gray), phase (brown), Pilot wire (Black)	
Warranty	2 anni	
Standard	EN 60335-1 EN 61000-3-2 EN 62233 EN 55014-1 NFC 15-100	EN 60335-2-30 EN61 000-3-3  EN 55014-2

Manufacturer: DELTACALOR s.r.l

Instruction manual available on the site:

<https://www.deltacalor.com/en/download/>

The symbol  placed on the device indicates the obligation to dispose of the device by entrusting to a specialized selective collection center, in accordance with Directive 2012/19 / EU. If the device needs to be replaced, it can be returned to the dealer. This device does not belong to the category of ordinary household waste. By eliminating it correctly you participate in protecting the environment and limiting the exploitation of natural resources.

Declaration of conformity: The manufacturer declares, under his exclusive responsibility, that the product concerned by this manual conforms to the prescriptions of the Low Voltage Directives 2014/35 / EU, EMC 2014/30 / EU and RoHS 2011/65 / EU.



**Model reference (s): TELICA WIFI PLUS****mode 1000 W**

<b>Features</b>	<b>Symbol</b>	<b>Value</b>	<b>Unit</b>
Thermal power			
Nominal heat output	$P_{nom}$	0.9	kW
Minimum heat output (indicative)	$P_{min}$	n.d.	kW
Maximum continuous heat output	$P_{max,c}$	0.9	kW
Auxiliary electricity consumption			
At nominal heat output	$el_{max}$	0.9	kW
At minimum heat output	$el_{min}$	n.d.	kW
In economy mode	$el_{SB}$	<0,0005	kW

**mode 1500 W**

<b>Features</b>	<b>Symbol</b>	<b>Value</b>	<b>Unit</b>
Thermal power			
Nominal heat output	$P_{nom}$	1.5	kW
Minimum heat output (indicative)	$P_{min}$	n.d.	kW
Maximum continuous heat output	$P_{max,c}$	1.5	kW
Auxiliary electricity consumption			
At nominal heat output	$el_{max}$	1.5	kW
At minimum heat output	$el_{min}$	n.d.	kW
In economy mode	$el_{SB}$	<0,0005	kW

**mode 2000 W**

<b>Features</b>	<b>Symbol</b>	<b>Value</b>	<b>Unit</b>
Thermal power			
Nominal heat output	$P_{nom}$	1.8	kW
Minimum heat output (indicative)	$P_{min}$	n.d.	kW
Maximum continuous heat output	$P_{max,c}$	1.8	kW
Auxiliary electricity consumption			
At nominal heat output	$el_{max}$	1.8	kW
At minimum heat output	$el_{min}$	n.d.	kW
In economy mode	$el_{SB}$	<0,0005	kW

**CNM Online**

T: 01977 663331

E: [cnmservice@cnmonline.co.uk](mailto:cnmservice@cnmonline.co.uk)Unit 2, North Point Business Park, Selby Road, Eggborough, North Yorkshire,  
DN14 0JT